



Product Innovations

11/2021

2021

EN



ZCC Cutting Tools Europe GmbH

your Partner | your Value

The Company

Zhuzhou Cemented Carbide Cutting Tools Co., Ltd. (ZCC-CT) is located in Zhuzhou, Hunan in the People's Republic of China is the largest Chinese manufacturer of carbide tools. ZCC-CT belongs to the Zhuzhou Cemented Carbide Group (ZCC), which manufactures carbide products and carbide powders. Both companies are part of the Minmetals Corporation, which Trades in mining metals and minerals.

Since its founding in 1953, ZCC Cutting Tools has become one of the world's leading carbide manufacturers and has more than 2,000 employees, thanks to its highly qualified staff and use of the latest technologies. As a Minmetals Corporation company, ZCC-CT can completely cover the entire value-added chain of modern carbide tool production from the extraction of raw materials to the coated final product and all the steps in between.

Based on the latest European production technologies, it is possible for us to offer products with a consistent high quality at all times. The extensive product range includes carbide indexable inserts, indexable inserts made from cermet, CBN, PKD and ceramic, solid carbide tools as well as turning tool holders and suitable tool systems. The products are produced in accordance with the current international standards, such as ISO, DIN, ANSI, JIS and BSI. In addition, ZCC Cutting Tools offer customer-specific solutions and special carbide products in accordance with specifications.

Research and development are a very high priority at ZCC-CT. In this area ZCC-CT use the world's most modern equipment and advanced machinery from Germany and Switzerland, for which the investments are higher than average. With highly trained engineers and a qualified international team, ZCC Cutting Tools researches the necessary foundations and is constantly developing new and improved products based on them. The company continuously strives to improve quality in order to meet customers' growing demands for new and innovative products and to be able to individually enhance customer benefits.

Both production and administration in China are subject to the ISO 9001:2008 standard. Environmental management is subject to the ISO 14001:2004 standard.

Since 2003, ZCC Cutting Tools has had a branch office in Europe.

The European head office and central warehouse are located in Düsseldorf, Germany. All European countries as well as Russia and Turkey are serviced from there. The company's quality management system is certified in the area of sales and logistics of tools for metal processing in accordance with DIN EN ISO 9001:2008.

In order to meet our own high requirements for above-average customer service and in parallel with the growth of the company as a whole, the number of employees at ZCC Cutting Tools is growing in sales and internal sales, in technical support and application technology, research and development as well as in the areas of logistic, marketing, IT, human resources and accounting.

Our sales representatives and our sales partners in Europe together serve customers on site. ZCC-CT application engineers are furthermore available with all their expertise and experience by phone, email or personally in your production environment.

The internal sales team handles enquiries throughout Europe with native speakers and ensures together with the employees in logistics that all orders are delivered to you and all our customers as fast as possible.

All of us at ZCC Cutting Tools Europe are here for you and will support you as your competent partner in all questions of machining production. That is our definition of added value through partnership.

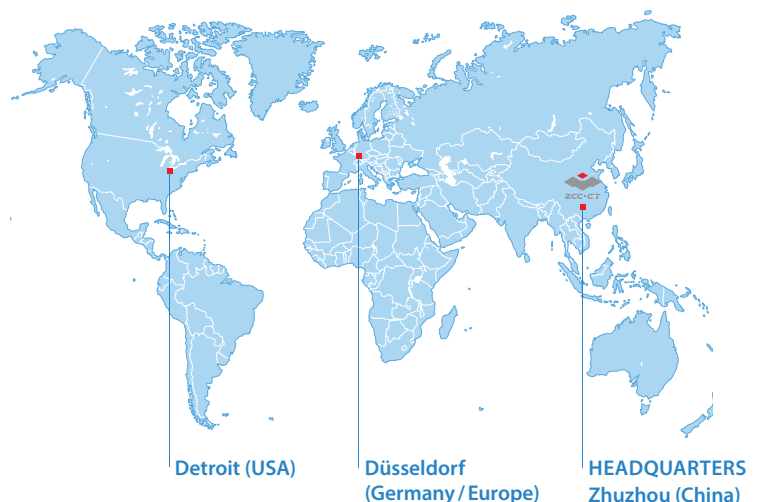

General turning

Chip breaker overview	A4–A5
Application fields of chip breakers	A6
Grade overview	A7
ISO code – general turning inserts	A8–A9
XM chip breaker	A10
XF chip breaker	A11
YBC grade	A12
Negative inserts	A13–A18
Positive inserts	A19–A24
RF / RH chip breaker	A25
LNUX inserts	A26
Negative inserts	A27
CNMM / CNMG inserts	A28
Negative inserts	A29
System code – external tool holders – rail applications	A30–A31
External tool holders – rail applications	A32–A34
ZNEX compact boring system	A35
PCBN & PCD inserts	A36
Boring bars	A37
Holdings – boring bars	A38



A

Turning

B

Milling

C

Drilling

D

Technical
Information

E

Index

A

Negative inserts

Finishing

XF

P



Double-sided chip breaker for finishing operations in the P application field. Superb chip control with low cutting forces.

Turning

B

RF

P



Double-sided chip breaker for applications from finishing to medium machining. (Rail applications)

Milling

Medium machining

XM

P

K



Double-sided chip breaker for medium machining operations in the P application field. Superb chip control at high and low feed rates.

Drilling

Roughing

RH

P



Double-sided chip breaker for applications from medium machining to roughing. (Rail applications)

D

Technical Information

E

Index

Positive inserts

Finishing

XF

P



Single-sided chip breaker for finishing operations in the P application field. Superb chip control with low cutting forces.

Medium machining

XM

P



Single-sided chip breaker for medium machining operations in the P application field. Superb chip control at high and low feed rates.

A

Turning

B

Milling

C

Drilling

D

Technical
Information

E

Index

A

Turning

Negative inserts

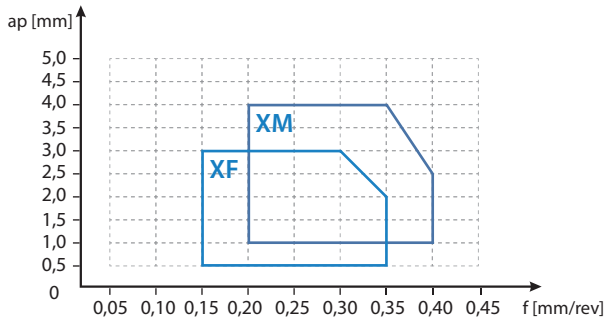

B

Milling

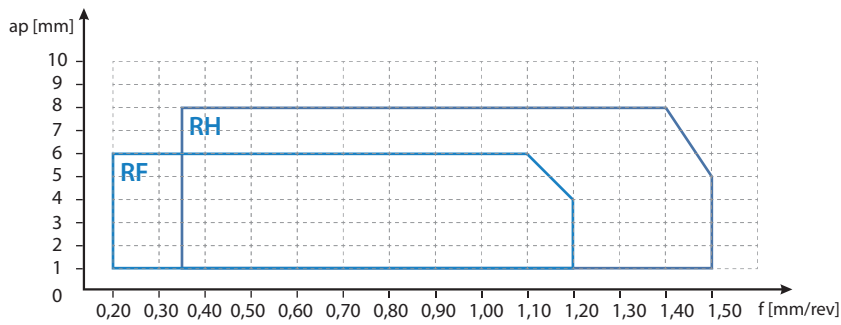

C

Drilling

Positive inserts

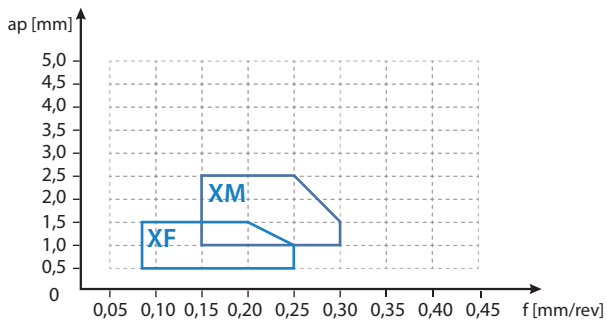

D

Technical Information

E

Index

Coated cemented carbide CVD

Grade	ISO	Grade description
YBC103	P05-P15	P10 grade with excellent wear resistance at higher cutting speeds. Latest sinter processes and CVD coating technologies enable a wide range of applications in the P material range.
YBC203	P15-P25	P20 grade with exceptional wear resistance and toughness for reliable machining operations. Ultra-modern sintering technique and CVD coating technologies allow for a wide range of applications in the P material range.

Application field

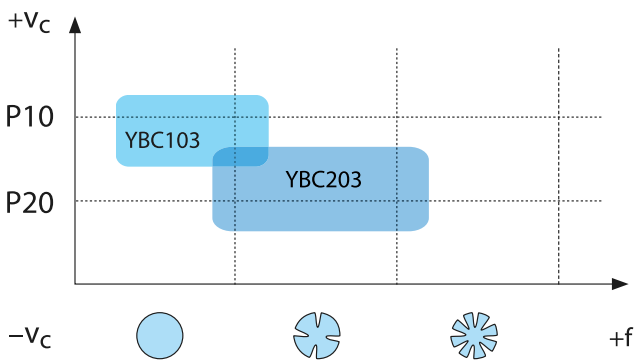

A

Turning

B

Milling

C

Drilling

D

Technical Information

E

Index

ISO standard

T N M G 22 04 08 (N) – DM

1 2 3 4 5 6 7 8 9

Insert shape		
A	B	C
D	E	H
K	L	M
O	P	R
S	T	T
V	W	Z Special

1

Clearance angle	
A	B
C	D
E	F
G	N
P	O Special

2

Tolerance class			
Code	I.C [mm]	m [mm]	S [mm]
A	±0,025	±0,005	±0,025
C	±0,025	±0,013	±0,025
E	±0,025	±0,025	±0,025
F	±0,013	±0,005	±0,025
G	±0,025	±0,025	±0,130
H	±0,013	±0,013	±0,025
J	±0,05–0,15	±0,005	±0,025
K	±0,05–0,15	±0,013	±0,025
L	±0,05–0,15	±0,025	±0,025
M	±0,05–0,15	±0,08–0,20	±0,130
N	±0,05–0,15	±0,08–0,20	±0,025
U	±0,08–0,25	±0,13–0,38	±0,130

3

Fastening features (metric)	
Insert shape	
A	B
C	F
G	H
J	M
N	Q
R	T
U	W
X Special	

4

Cutting edge length l [mm]								
I.C [mm]	Insert shape							
3,97	06							
5,0	05							
5,56	09							
6,0	06							
6,35	06	07			11	11		
8,0	08							
9,525	09	11	09	09	16	16	06	16
10,0	10							
12,0	12							
12,7	12	15	12	12	22	22	08	
15,875	16		15	15	27			
16,0	16							
19,05	19		19	19	33			
20,0	20							
25,0	25	25	25					
25,4	25 25							
31,75	31							
32	32							

5

Insert thickness S [mm]			
Code	S	Code	S
00	0,79	T5	5,95
T0	0,99	06	6,35
01	1,59	T6	6,75
T1	1,98	07	7,94
02	2,38	09	9,52
T2	2,58	T9	9,72
03	3,18	11	11,11
T3	3,97	12	12,70
04	4,76		
T4	4,96		
05	5,56		

6

Nose radius r [mm]	
Code	r
00	–
02	0,2
04	0,4
08	0,8
12	1,2
16	1,6
20	2,0
24	2,4
32	3,2
X	Special
MO	Round inserts

7

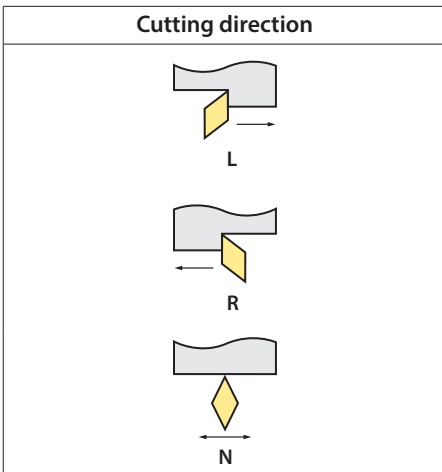

8

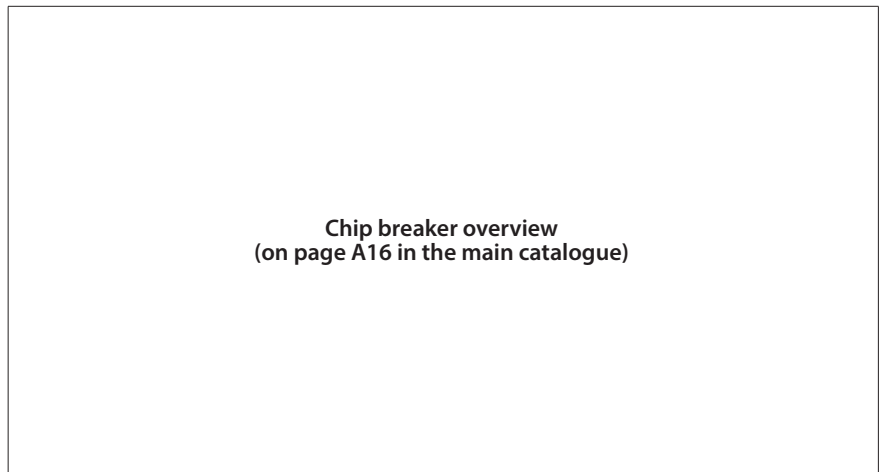

9

ANSI standard

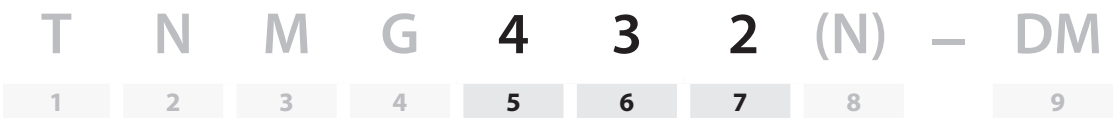

Inner circle		
Code	[mm]	Pouce
2	6.35	0.250
3	9.525	0.375
4	12.7	0.500
5	15.875	0.625
6	19.05	0.750
8	25.4	1.000

5

Insert thickness		
Code	[mm]	Pouce
2	3.18	0.125
3	4.76	0.187
4	6.35	0.250
5	7.94	0.313
6	9.52	0.375

6

Nose radius		
Code	[mm]	Pouce
0	0.2	0.008
1	0.4	0.016
2	0.8	0.031
3	1.2	0.047
4	1.6	0.063
5	2.0	0.079
6	2.4	0.094

7

XF chip breaker

For maximum control

YOUR BENEFITS

- Chip-forming elements for maximum chip control at low cutting depths
- Optimally prepared cutting edges for minimal vibration
- Optimised rake angle for minimal heat build-up and low power consumption
- Excellent surface quality across a wide range of applications

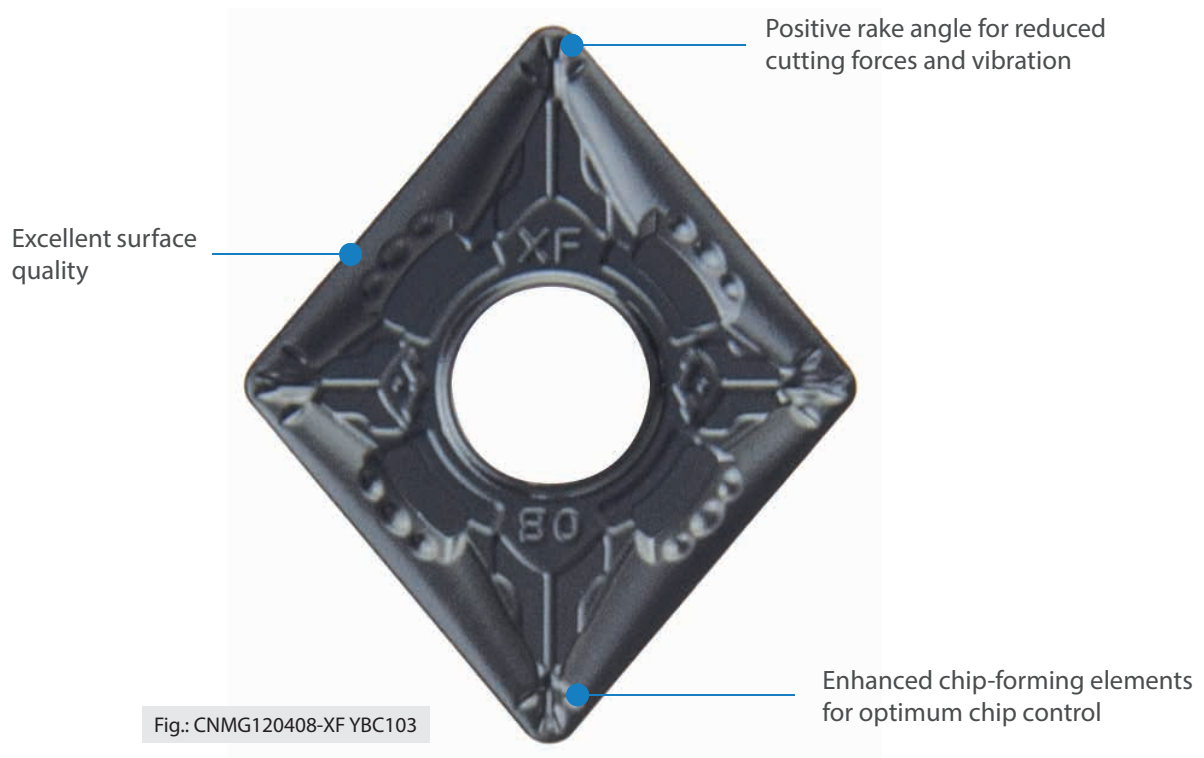

XM chip breaker

High-performance all-round tool

YOUR BENEFITS

- Positive rake angle for low cutting forces at high feed rates
- Recommended for low-power machines
- Excellent chip control even at low cutting depths thanks to optimum positioning of chip-forming elements
- Reinforced cutting edge for reduced chip impact damage

Positive rake angle for reduced cutting forces and vibration

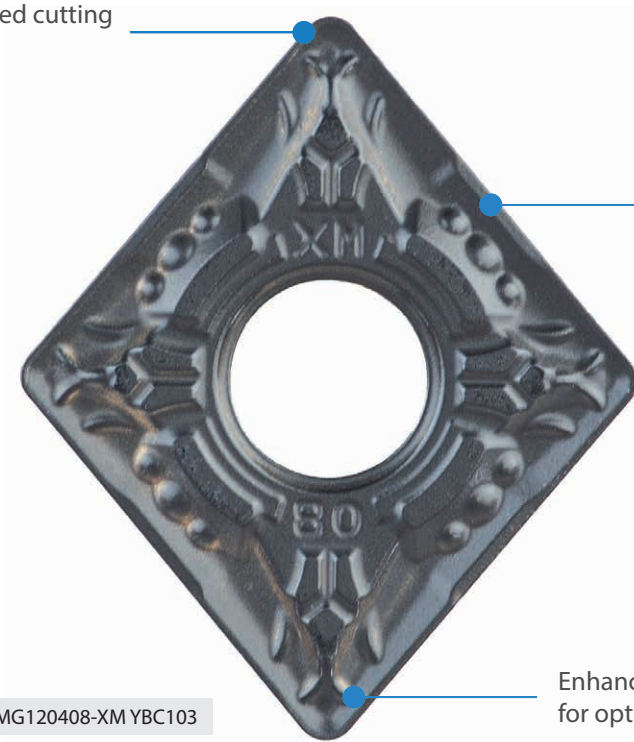

Reinforced cutting edge

Enhanced chip-forming elements for optimum chip control

Fig.: CNMG120408-XM YBC103

YBC grade

For unrivalled productivity and reliability

YOUR BENEFITS

- Maximum productivity and reliability
- Optimised coating stability for excellent wear resistance at high cutting speeds
- Low built-in stress of CVD coating prevents abrupt chipping
- For use in a wide range of P applications
- Wear identification on the flank face



Fig.: CNMG120408-XM YBC103

YBC103

Where maximum productivity is what matters most



YBC203

Where maximum reliability is what matters most

CNMG	L	I.C	S	d
12 04	12.9	12.7	4.76	5.16
16 06	16.1	15.875	6.35	6.35
19 06	19.3	19.05	6.35	7.94

- Ideal machining conditions
- ⊗ Normal machining conditions
- ⊗ Unfavourable machining conditions

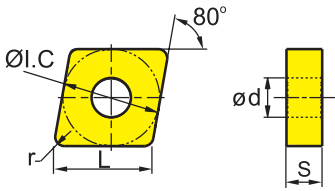
Turning inserts

CN** negative insert					HC ¹ (CVD)								HC ¹ (PVD)			HT	HC ²	HW											
					P	M	K	N	S	H																			
					ISO					r	a _p	f																	
					YBC103	YB6315	YBC152	YBC203	YBC252	YBC352	YBM153	YBM253	YBD102	YB7315	YBD152	YBD152C	YBG101	YBG102	YBG105	YBG205	YB9320	YPD201	YBS103	YNG151	YNT251	YNG151C	YD101	YD201	
 Finishing	CNMG120404-XF	0.4	0.5-2.5	0.1-0.25	●	●																							
	CNMG120408-XF	0.8	0.5-2.5	0.1-0.30	●	●																							
	CNMG120412-XF	1.2	0.5-2.5	0.1-0.35	●	●																							
 Medium Cut	CNMG120404-XM	0.4	1-4.2	0.2-0.3	●	○																							
	CNMG120408-XM	0.8	1-4.2	0.2-0.4	●	●																							
	CNMG120412-XM	1.2	1-4.2	0.2-0.6	●	●																							
	CNMG120416-XM	1.6	1-4.2	0.2-0.65	●	●																							
	CNMG160608-XM	0.8	1-5.6	0.2-0.4	●	●																							
	CNMG160612-XM	1.2	1-5.6	0.2-0.6	●	●																							
	CNMG160616-XM	1.6	1-5.6	0.2-0.65	○	●																							
	CNMG190608-XM	0.8	1-6.65	0.2-0.4	●	●																							
	CNMG190612-XM	1.2	1-6.65	0.2-0.6	○	●																							
CNMG190616-XM	1.6	1-6.65	0.2-0.65	○	●																								

● Ex stock ○ On demand

HC¹ Coated carbide
 HT Uncoated cermet
 HC² Coated cermet
 HW Uncoated carbide

Register on our website and order online now.



www.zcct-europe.com

A

Turning

- Ideal machining conditions
- ⊗ Normal machining conditions
- ⊛ Unfavourable machining conditions

TNMG	L	I.C	S	d
16 04	16.5	9.525	4.76	3.81
22 04	22	12.7	4.76	5.16

Turning inserts

TN** negative insert				HC ¹ (CVD)								HC ¹ (PVD)			HT	HC ²	HW													
	P	M	K	N	S	H	YBC103	YB6315	YBC152	YBC203	YBC252	YBC352	YBM153	YBM253	YBD102	YB7315	YBD152	YBD152C	YBG101	YBG102	YBG105	YBG205	YB9320	YPD201	YBS103	YNG151	YNT251	YNG151C	YD101	YD201
	ISO	r	a _p	f																										
	XF Finishing	TNMG160404-XF	0,4	0,5-2,5	0,1-0,25	●	●																							
		TNMG160408-XF	0,8	0,5-2,5	0,1-0,30	●	●																							
	XM Medium Cut	TNMG160404-XM	0,4	1-5,6	0,2-0,4	●	○																							
		TNMG160408-XM	0,8	1-5,6	0,2-0,4	●	●																							
TNMG160412-XM		1,2	1-5,6	0,2-0,6	●	●																								
TNMG160416-XM		1,6	1-5,6	0,2-0,65	○	●																								
TNMG220408-XM		0,8	1-7,7	0,2-0,4	●	●																								
TNMG220412-XM		1,2	1-7,7	0,2-0,6	●	●																								
TNMG220416-XM	1,6	1-7,7	0,2-0,65	○	●																									

● Ex stock ○ On demand

HC¹ Coated carbide
 HT Uncoated cermet
 HC² Coated cermet
 HW Uncoated carbide

B

Milling

C

Drilling

D

Technical Information

E

Index

Register on our website and order online now.



www.zcct-europe.com

A

Turning

- Ideal machining conditions
- ⊗ Normal machining conditions
- ⊛ Unfavourable machining conditions

WNMG	L	I.C	S	d
06 04	6.5	9.525	4.76	3.81
08 04	8.7	12.7	4.76	5.16

Turning inserts

WN** negative insert				HC ¹ (CVD)										HC ¹ (PVD)		HT	HC ²	HW															
	P	M	K	N	S	H	YBC103	YB6315	YBC152	YBC203	YBC252	YBC352	YBM153	YBM253	YBD102	YB7315	YBD152	YBD152C	YBG101	YBG102	YBG105	YBG205	YB9320	YPD201	YBS103	YNG151	YNT251	YNG151C	YD101	YD201			
	ISO	r	a _p	f																													
	XF Finishing	WNMG080404-XF	0,4	0,5-2,5	0,1-0,25	●	●																										
		WNMG080408-XF	0,8	0,5-2,5	0,1-0,30	●	●																										
		WNMG080412-XF	1,2	0,5-2,5	0,1-0,35	●	●																										
	XM Medium Cut	WNMG060404-XM	0,4	1-2,1	0,2-0,4	●	○																										
WNMG060408-XM		0,8	1-2,1	0,2-0,4	●	●																											
WNMG060412-XM		1,2	1-2,1	0,2-0,6	●	●																											
WNMG080404-XM		0,4	1-2,8	0,2-0,4	●	●																											
WNMG080408-XM		0,8	1-2,8	0,2-0,4	●	●																											
WNMG080412-XM		1,2	1-2,8	0,2-0,6	●	●																											
WNMG080416-XM	1,6	1-2,8	0,2-0,65	○	○																												

● Ex stock ○ On demand

HC¹ Coated carbide
 HT Uncoated cermet
 HC² Coated cermet
 HW Uncoated carbide

B

Milling

C

Drilling

D

Technical Information

E

Index

Register on our website and order online now.



www.zcct-europe.com

CCMT	L	I.C	S	d
06 02	6.4	6.35	2.38	2.8
09 T3	9.7	9.525	3.97	4.4
12 04	12.9	12.7	4.76	5.56

- Ideal machining conditions
- Normal machining conditions
- Unfavourable machining conditions

Turning inserts

CC** positive insert				HC ¹ (CVD)										HC ¹ (PVD)			HT	HC ²	HW																		
ISO	r	a _p	f	P	M	K	N	S	H	YBC103	YB6315	YBC152	YBC203	YBC252	YBC352	YBM153	YBM253	YBD102	YB7315	YBD152	YBD152C	YBG101	YBG102	YBG105	YBG205	YB9320	YPD201	YBS103	YNG151	YNT251	YNG151C	YD101	YD201				
				XF	0,4	0,5-1,5	0,08-0,15	●	●	●	●	●	●	●	●	●	●	●	●	●	●	●	●	●	●	●	●	●	●	●	●	●	●	●	●	●	●
Finishing	0,4	0,5-2,0	0,08-0,2	●	●	●	●	●	●	●	●	●	●	●	●	●	●	●	●	●	●	●	●	●	●	●	●	●	●	●	●	●	●	●			
	0,8	0,5-2,0	0,08-0,25	●	●	○	○	○	○	○	○	○	○	○	○	○	○	○	○	○	○	○	○	○	○	○	○	○	○	○	○	○	○	○	○		
Medium Cut	0,4	1-2,5	0,15-0,3	●	●	○	○	○	○	○	○	○	○	○	○	○	○	○	○	○	○	○	○	○	○	○	○	○	○	○	○	○	○	○	○		
	0,8	1-2,5	0,15-0,35	●	●	○	○	○	○	○	○	○	○	○	○	○	○	○	○	○	○	○	○	○	○	○	○	○	○	○	○	○	○	○	○	○	
	1,2	1-2,5	0,15-0,4	●	●	○	○	○	○	○	○	○	○	○	○	○	○	○	○	○	○	○	○	○	○	○	○	○	○	○	○	○	○	○	○	○	○
	0,4	1-3,0	0,15-0,3	○	○	○	○	○	○	○	○	○	○	○	○	○	○	○	○	○	○	○	○	○	○	○	○	○	○	○	○	○	○	○	○	○	○
	0,8	1-3,0	0,15-0,35	○	○	○	○	○	○	○	○	○	○	○	○	○	○	○	○	○	○	○	○	○	○	○	○	○	○	○	○	○	○	○	○	○	○
	1,2	1-3,0	0,15-0,4	○	○	○	○	○	○	○	○	○	○	○	○	○	○	○	○	○	○	○	○	○	○	○	○	○	○	○	○	○	○	○	○	○	○

● Ex stock ○ On demand

HC¹ Coated carbide
 HT Uncoated cermet
 HC² Coated cermet
 HW Uncoated carbide

A Turning
B Milling
C Drilling
D Technical Information
E Index

A

Turning

- Ideal machining conditions
- ⊗ Normal machining conditions
- ⊛ Unfavourable machining conditions

DCMT	L	I.C	S	d
07 02	7.8	6.35	2.38	2.8
11 T3	11.6	9.525	3.97	4.4

Turning inserts

DC** positive insert		HC ¹ (CVD)						HC ¹ (PVD)		HT	HC ²	HW	
	P	●	●	●	⊗	⊗	⊗	●	⊗	●	⊗		
	M				●	⊗		●	⊗	●	⊗		
	K						●	⊗					
	N							●	●			●	⊗
	S								●	⊗		●	⊗
	H												

B

Milling

ISO		r	a _p	f	YBC103	YB6315	YBC152	YBC203	YBC252	YBC352	YBM153	YBM253	YBD102	YB7315	YBD152	YBD152C	YBG101	YBG102	YBG105	YBG205	YB9320	YPD201	YBS103	YNG151	YNT251	YNG151C	YD101	YD201
XF 	DCMT070204-XF	0,4	0,5-1,5	0,08-0,15	○																							
	DCMT070208-XF	0,8	0,5-1,5	0,08-0,25	○																							
	DCMT11T304-XF	0,4	0,5-2,0	0,08-0,15	●																							
	DCMT11T308-XF	0,8	0,5-2,0	0,08-0,25	●																							
XM 	DCMT11T304-XM	0,4	1-2,5	0,15-0,3	●		○																					
	DCMT11T308-XM	0,8	1-2,5	0,15-0,35	●		●																					
	DCMT11T312-XM	1,2	1-2,5	0,15-0,4	●		●																					
Medium Cut																												

● Ex stock ○ On demand

HC¹ Coated carbide
 HT Uncoated cermet
 HC² Coated cermet
 HW Uncoated carbide

C

Drilling

D

Technical Information

E

Index

Register on our website and order online now.

www.zcct-europe.com

A

Turning

- Ideal machining conditions
- ⊗ Normal machining conditions
- ⊗ Unfavourable machining conditions

TCMT	L	I.C	S	d
16 T3	16.5	9.525	3.97	4.4

Turning inserts

TC** positive insert				HC ¹ (CVD)								HC ¹ (PVD)			HT	HC ²	HW										
				P	●	●	●	⊗	⊗	⊗					⊗	⊗	●	⊗	●								
				M														●	●								
				K																							
				N														●	●								
				S																							
				H																							
ISO	r	a _p	f	YBC103	YB6315	YBC152	YBC203	YBC252	YBC352	YBM153	YBM253	YBD102	YB7315	YBD152	YBD152C	YBG101	YBG102	YBG105	YBG205	YB9320	YPD201	YBS103	YNG151	YNT251	YNG151C	YD101	YD201
XM	TCMT16T304-XM	0,4	1-3,0	0,15-0,3	○	○																					
	TCMT16T308-XM	0,8	1-3,0	0,15-0,35	○	○																					
Medium Cut	TCMT16T312-XM	1,2	1-3,0	0,15-0,4	○	○																					

● Ex stock ○ On demand

HC¹ Coated carbide
 HT Uncoated cermet
 HC² Coated cermet
 HW Uncoated carbide

B

Milling

C

Drilling

D

Technical Information

E

Index



Register on our website and order online now.

www.zcct-europe.com

- Ideal machining conditions
- ⊗ Normal machining conditions
- ⊗ Unfavourable machining conditions

VBMT	L	I.C	S	d
16 04	16.5	9.525	4.76	4.4

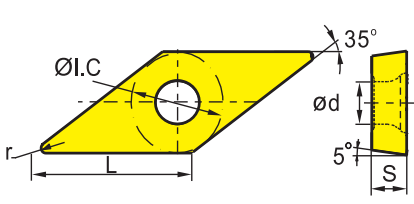
Turning inserts

VB** positive insert				HC ¹ (CVD)								HC ¹ (PVD)			HT	HC ²	HW										
				P	M	K	N	S	H																		
																											
ISO	r	a _p	f	YBC103	YB6315	YBC152	YBC203	YBC252	YBC352	YBM153	YBM253	YBD102	YB7315	YBD152	YBD152C	YBG101	YBG102	YBG105	YBG205	YB9320	YPD201	YBS103	YNG151	YNT251	YNG151C	YD101	YD201
XM	VBMT160404-XM	0,4	1-2,5	0,15-0,25	●	○																					
 Medium Cut	VBMT160408-XM	0,8	1-2,5	0,15-0,3	●	○																					
	VBMT160412-XM	1,2	1-2,5	0,15-0,35	●	○																					

● Ex stock ○ On demand

HC¹ Coated carbide
 HT Uncoated cermet
 HC² Coated cermet
 HW Uncoated carbide

A

Turning

B

Milling

C

Drilling

D

Technical Information

E

Index

A

Turning

- Ideal machining conditions
- ⊗ Normal machining conditions
- ⊗ Unfavourable machining conditions

VCMT	L	I.C	S	d
16 04	16	9.525	4.76	4.4

Turning inserts

VC** positive insert				HC ¹ (CVD)										HC ¹ (PVD)		HT	HC ²	HW										
				P	●	●	●	⊗	⊗	⊗									●	⊗	●							
				M						●	⊗	●	●	⊗	⊗	⊗	●	●	●									
				K																								
				N												●	●							●	⊗			
				S																								
				H																								
ISO	r	a _p	f	YBC103	YB6315	YBC152	YBC203	YBC252	YBC352	YBM153	YBM253	YBD102	YB7315	YBD152	YBD152C	YBG101	YBG102	YBG105	YBG205	YB9320	YPD201	YBS103	YNG151	YNT251	YNG151C	YD101	YD201	
XM	VCMT160412-XM	1,2	1-2,5	0,15-0,35	○	○																						
	Medium Cut																											

● Ex stock ○ On demand

HC¹ Coated carbide
 HT Uncoated cermet
 HC² Coated cermet
 HW Uncoated carbide

B

Milling

C

Drilling

D

Technical Information

E

Index

Register on our website and order online now.



www.zcct-europe.com

RF/RH chip breaker

The rail specialists

YOUR BENEFITS

RF chip breaker

- Excellent chip control even at low cutting depths thanks to optimum positioning of chip-forming elements

RH chip breaker

- Positive rake angle for low cutting forces at high feed rates
- Reinforced cutting edge for reduced chip impact damage

Enhanced chip-forming elements for optimum chip control



Fig.: LNUX191940-RF

Cutting edges prepared consistently for reliable machining



Fig.: LNUX191940-RH

Active chip breaker for optimum results

Curved cutting edge for reduced cutting forces

LINUX inserts

The rail specialists

YOUR BENEFITS

- Easy to use thanks to plug-and-play
- Highly flexible
- Minimal inventory costs
- No need to switch to a new tool system with the high costs this entails



Fig.: LNUX191940-RF

All-in-one solution:

Compatible with all commercially available clamping systems thanks to our innovative bore hole design

The following versions are available

LNUX301940-RF
LNUX191940-RF

LNUX301940-RH
LNUX191940-RH



Compatible cassettes (see page A32)

RW-PLANR/L-19
RW-PLANR/L-30

RW-PLFNR/L-19



Turning inserts

- Ideal machining conditions
- ⊗ Normal machining conditions
- ⊗ Unfavourable machining conditions

LNUX	L	I.C	S	d
19 19	19.05	10	19.05	6.35
30 19	30	10	19.05	6.35

LN** negative insert					HC ¹ (CVD)								HC ¹ (PVD)				HT	HC ²	HW								
					P	M	K	N	S	H																	
					●	●	●	●	●	⊗								●	⊗	●							
									●	⊗	●	●	●	●	●	●	●	●									
										⊗																	
											●	●					●	⊗									
											●	●	●	●	●	●		●	⊗								
ISO	r	a _p	f																								
RF	LNUX191940-RF	4.0	1,0-5,5	0,2-0,8	YBC103	YB6315	YBC152	YBC203	YBC252	YBC352	YBM153	YBM253	YBD102	YBD152	YBD152C	YBG101	YBG102	YBG105	YBG205	YB9320	YPD201	YBS103	YNG151	YNT251	YNG151C	YD101	YD201
	LNUX301940-RF	4.0	1,0-6,0	0,2-1,2	●	●																					
RH	LNUX191940-RH	4.0	1,5-6,0	0,35-1,2	●	●																					
	LNUX301940-RH	4.0	2,0-7,0	0,35-1,5	●	●																					

● Ex stock ○ On demand

HC¹ Coated carbide
 HT Uncoated cermet
 HC² Coated cermet
 HW Uncoated carbide

A

Turning

B

Milling

C

Drilling

D

Technical Information

E

Index

Register on our website and order online now.



www.zcct-europe.com

CNMM/CNMG inserts

The rail specialists

YOUR BENEFITS

- Simple plug-and-play solution
- Inserts compatible with all standard tool holders used in rail applications
- Lower capital and inventory costs

Available in the two high-performance cutting materials we offer (YBC152/YBC252)

Available as one-sided or double-sided inserts

Available with the new RF and RH chip breakers

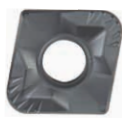

Fig.: CNMM191140-RF

The following versions are available:

CNMM190740-RF
CNMG191140-RF
CNMM191140-RF

CNMM190740-RH
CNMM191140-RH



Compatible cassettes (see page A34)





RW-PCLNR/L-1907

RW-PCLNR/L-1911



- Ideal machining conditions
- Normal machining conditions
- Unfavourable machining conditions

CN**	L	I.C	S	d
19 07	19.3	19.05	7.94	7.93
19 11	19.3	19.05	11	7.8

CN** negative insert				HC ¹ (CVD)								HC ¹ (PVD)			HT	HC ²	HW												
ISO	r	a _p	f	YBC103	YB6315	YBC152	YBC203	YBC252	YBC352	YBM153	YBM253	YBD102	YB7315	YBD152	YBD152C	YBG101	YBG102	YBG105	YBG205	YB9320	YPD201	YBS103	YNG151	YNT251	YNG151C	YD101	YD201		
 CNMG191140-RF	4.0	1.0-4.0	0.15-0.6	●																									
 CNMM190740-RF	4.0	1.0-4.0	0.15-0.6	●																									
 CNMM191140-RF	4.0	1.0-4.0	0.15-0.6	●																									
 CNMM190740-RH	4.0	1.5-7.0	0.2-0.7	●	●																								
 CNMM191140-RH	4.0	1.5-7.0	0.2-0.7	●	●																								

● Ex stock ○ On demand

HC¹ Coated carbide
 HT Uncoated cermet
 HC² Coated cermet
 HW Uncoated carbide

A

Turning

B

Milling

C

Drilling

D

Technical Information

E

Index

Register on our website and order online now.



www.zcct-europe.com

A

Turning

B

Milling

C

Drilling

D

Technical Information





E







Index

RW P L F N L/R 19

1 2 3 4 5 6 7

(RW = Rail Way)
Tool holders for rail applications





















Clamping system	
Code	Description
P	Lever lock clamping 
M	Wedge/pin lock clamping 
S	Screw-on clamping 
C/J	Wedge clamping 
D	Duel wedge clamping 

Insert shape	
C	
D	
R	
S	
T	
V	
L	



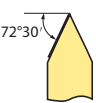
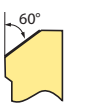
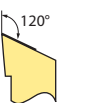

1

2

3

Tool holder type and entering angle				
				
A	B	C	D	E
				
F	G	H	J	K
				
L	M	N	O	P
				
Q	R	S	T	U
				
V	W	X		

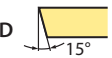
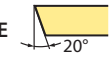
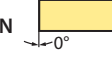
4

Clearance angle	
	
B	C
	
D	E
	
N	P

5

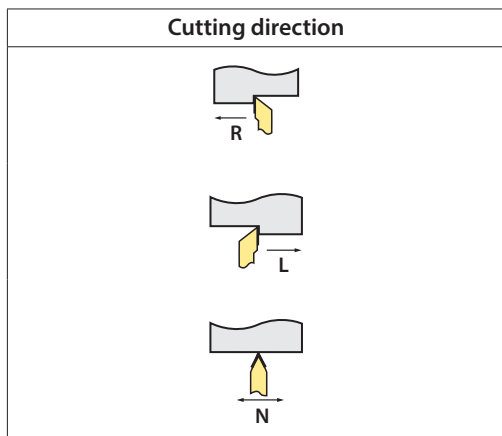

6

Cutting edge length l [mm]

I.C [mm]	Insert shape						
	C	D	R	S	T	V	W
5,56					09		
6,35	06	07			11		
9,525	09	11	09	09	16	16	06
12,7	12	15	12	12	22	22	08
15,875	16	19	15	15	27		
19,05	19		19	19	33		
25,4	25		25	25	44		
32			32				

7

A

Turning

B

Milling

C

Drilling

D

Technical Information

E

Index

A

LN** Holder (external) P clamping

PLANR/L

Turning

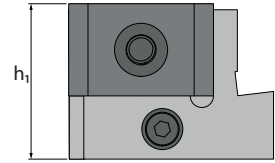
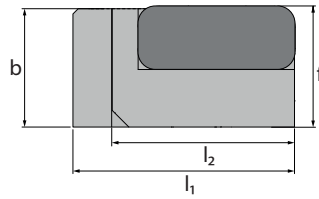

B

Milling



Article	*	Stock		Dimensions [mm]					Insert
		R	L	h ₁	l ₁	l ₂	b	f	
RW-PLANR-19	•			32	43	35	22,5	23	LNUX19**
RW-PLANL-19	•		•	32	43	35	22,5	23	LNUX19**
RW-PLANR-30	•			32	43	35	22,5	23	LNUX30**
RW-PLANL-30	•		•	32	43	35	22,5	23	LNUX30**

● Ex stock ○ On demand

* With internal cooling

C

Drilling

Spare parts			
	Insert	LNUX19**	LNUX30**
	Knee lever	L5RWL	L5RWL
	Screw	LEM8x25RWL	LEM8x25RWL
	Wrench	WH30L	WH30L

D

Technical Information

E

Index

Register on our website and order online now.



www.zcct-europe.com

LN Holder (external)** **P clamping**

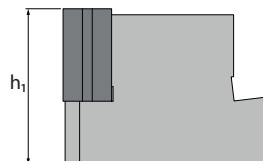
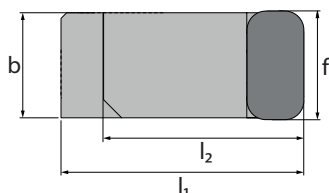

PLFNR/L



Article	*	Stock		Dimensions [mm]					Insert
		R	L	h ₁	l ₁	l ₂	b	f	
RW-PLFNR-19	•			32	43	35	18,6	19	LNUX19**
RW-PLFNL-19		•		32	43	35	18,6	19	LNUX19**

• Ex stock ○ On demand

* With internal cooling

Spare parts		
	Insert	LNUX19**
	Knee lever	L5RWL
	Screw	LEM8x25RWL
	Wrench	WH30L

A

Turning

B

Milling

C

Drilling

D

Technical Information

E

Index

A

CN** Holder (external) P clamping

PCLNR/L

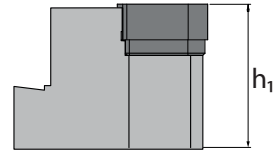
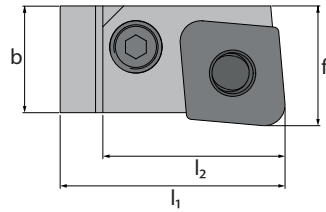

Turning

B





Article	*	Stock		Dimensions [mm]					Insert
		R	L	h_1	l_1	l_2	b	f	
RW-PCLNR-1907	•			32	43	35	24,8	26	CNM*1907
RW-PCLNL-1907			•	32	43	35	24,8	26	CNM*1907
RW-PCLNR-1911	•			32	43	35	24,8	26	CNM*1911
RW-PCLNL-1911			•	32	43	35	24,8	26	CNM*1911

Milling

• Ex stock ○ On demand

* With internal cooling

C

Spare parts			
	Insert	CNM*1907	CNM*1911
	Knee lever	L5RWC	L5RWC
	Screw	LEM8x25RWC	LEM8x25RWC
	Shim	C19RWC	C19RWC
	Shim pin (Shim)	SP5RWC	SP5RWC
	Wrench	WH30L	WH30L

Drilling

D

Technical Information

E

Index

Register on our website and order online now.



www.zcct-europe.com

ZNEX compact boring system

Specialised tool for cutting hard metals

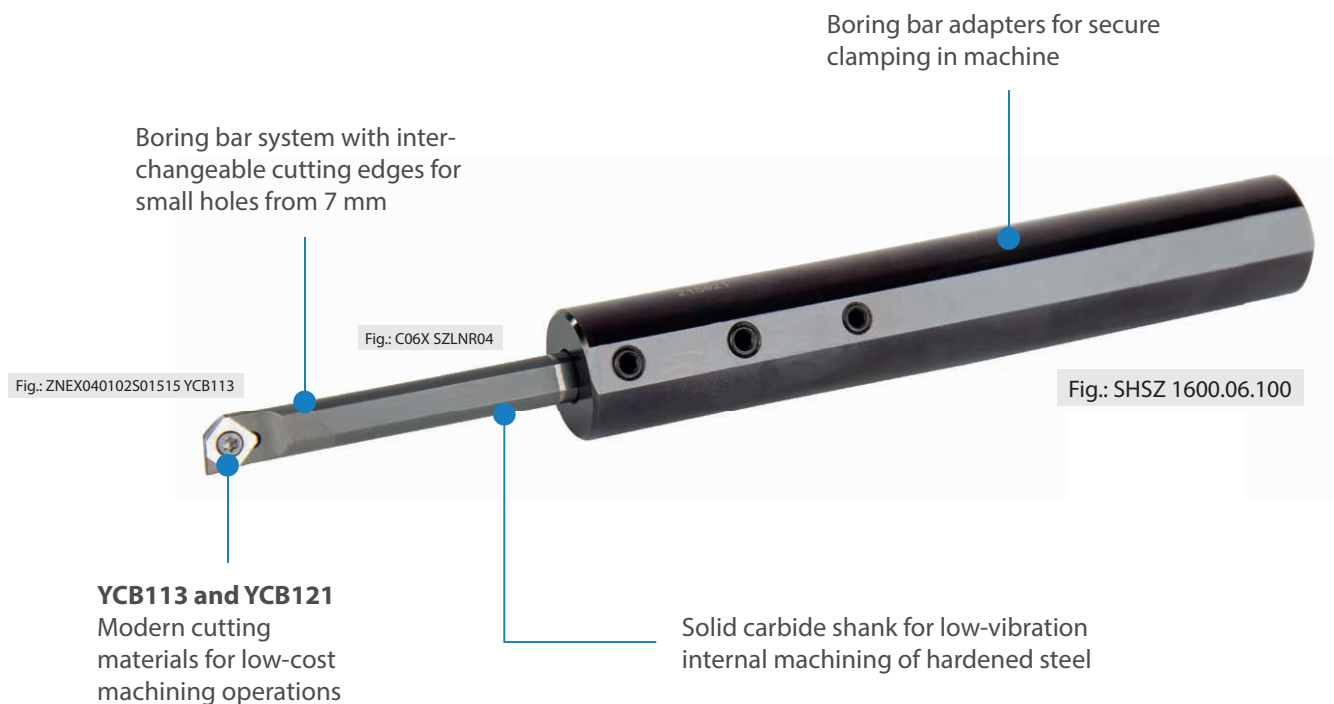

YOUR BENEFITS

- Ability to machine small holes with interchangeable cutting edges
- Modern cutting materials
- Range of nose radii
- Durable system











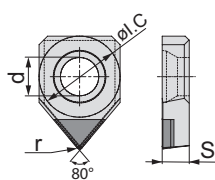

A

Turning

-  Ideal machining conditions
-  Normal machining conditions
-  Unfavourable machining conditions

ZNEX	I.C	S	d
04 01	4,76	1,59	2,3

Turning CBN inserts

ZN** negative insert					BL (CBN)	BC (CBN)	BH (CBN)	
					P			
					M			
					K			
					N			
					S			
					H			
ISO	r	a _p	f	YCB112 YCB113 YCB121 YCB131	YCB113C YCB121C YCB131C	YCB215		
	ZNEX040102S01515	0,2	0,08-0,50	0,05-0,15	 			
	ZNEX040104S01515	0,4	0,08-0,50	0,05-0,20	 			

● Ex stock ○ On demand

BL CBN with a low CBN content
 BC CBN with coating
 BH CBN with a high CBN content

B

Milling

C

Drilling

D

Technical Information

E

Index

Register on our website and order online now.



www.zcct-europe.com

ZNEX solid carbide boring bar **S clamping**

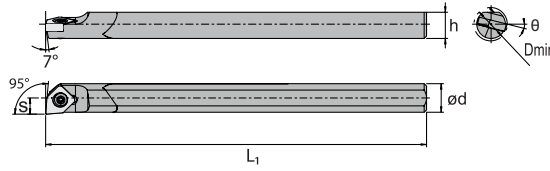

SZLNR Kr: 95°



Article	*	Stock		Dimensions [mm]						Insert	
		R	L	D _{min}	ød	h	s	L ₁	L ₂	θ	
C06X-SZLNR04	●			7	6	5,5	3,4	80	-	-14	ZNEX0401**

● Ex stock ○ On demand

* With internal cooling

Spare parts		
	Insert	ZNEX0401**
	ød	6
	Screw	I60M2x3,7 (0,5 Nm)
	Wrench (Screw)	WT06IP

A

Turning

B

Milling

C

Drilling

D

Technical Information

E

Index

A

C06X** holder

SZLNR Kr: 95°

Turning

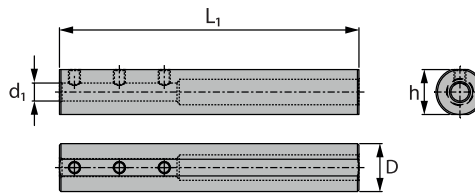

B



Article	Stock	Dimensions [mm]			
		D	d ₁	L ₁	h
SHSZ1600.06.100	●	16	6	100	15

Milling

● Ex stock ○ On demand

* With internal cooling

C

Spare parts		
	Screw	M4x5SH
	Wrench (Screw)	WH20L

Drilling

D

Technical Information

E

Index

Register on our website and order online now.



www.zccct-europe.com

Modular grooving system

zFlex – Now also available for deep parting operations **A40–A41**

Tool orientation **A42**

Base cartridge – parting operations **A43**

Primary cartridge – parting operations **A44**

Inserts **A45–A46**

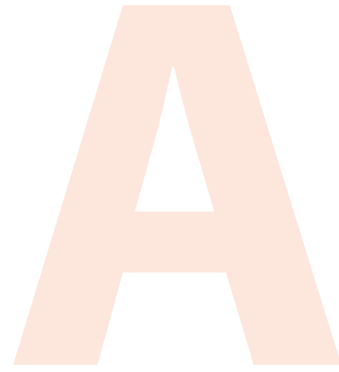

A

Turning

B

Milling

C

Drilling

D

Technical
Information

E

Index



Modular grooving system

Now also available for deep parting operations **New**

The tool holder is compatible with all primary cartridges, meaning it can be used in any grooving operation

Interlocking system ensures the tool holder and cartridge fit together seamlessly

Fig.: ZF.0.3.3.0.A.R

ELI (External Like Internal) coolant supply system

Reinforced base for maximum stability

Please refer to **Product Innovations 05/2021** for more information on our zFlex modular grooving system:



Product Innovations 05/2021

YOUR BENEFITS

- Now also available with strengthened base and primary cartridges for parting operations up to $\varnothing 80$ mm
- Flat, smooth results thanks to high system rigidity
- Gain flexibility and save time in production
- Minimal wear and tear on spare parts thanks to rugged design of tool system
- ELI coolant supply as a low-cost alternative to internal cooling
- Spring tension minimises plastic deformation of the clamping finger

Fig.: ZF.1.2.R.EC

New

Base cartridge makes replacing the primary cartridge a snap

Maximum flexibility thanks to spring tension mechanism

Fig.: ZF.2.2.FR80.EC

New

Tool orientation

VDI base adapter

Radial tool orientation if spindle rotates **left**

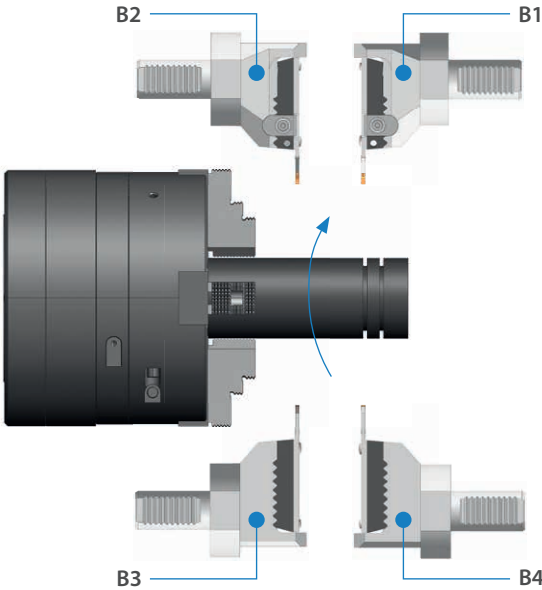

Radial tool orientation if spindle rotates **right**

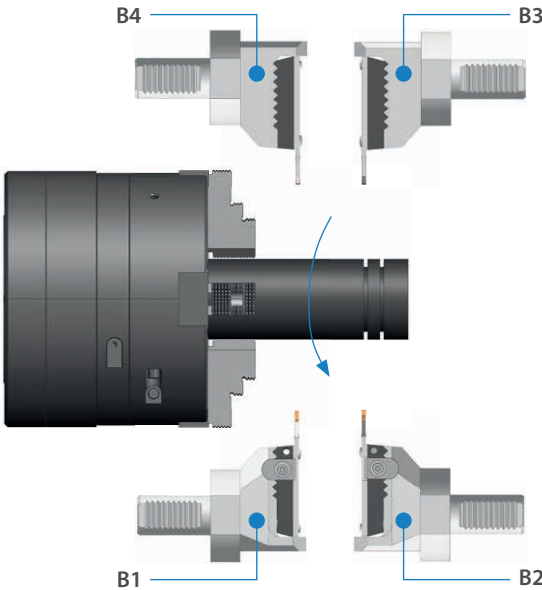

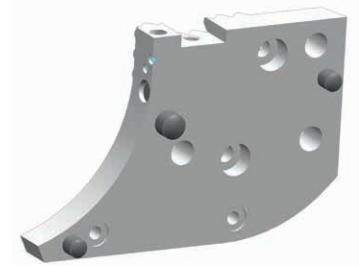
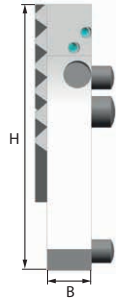
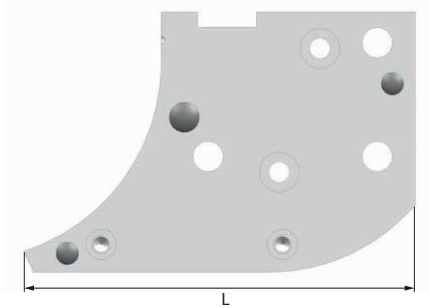

Base cartridge – parting operations



Article	*	Stock		Dimensions [mm]		
		R	L	B	L	H
ZF.1.2.R/L.EC	ext.	●	●	14,25	102,5	68

● Ex stock ○ On demand

Spare parts			
		Article	Stock
	Screw	ZF.1.M5x25	●
	Seal	ZF.1.S.0	●
	Wrench	WH40L	●

Register on our website and order online now.



www.zccct-europe.com

A

Turning

B

Milling

C

Drilling

D

Technical Information

E

Index

Primary cartridge – parting operations

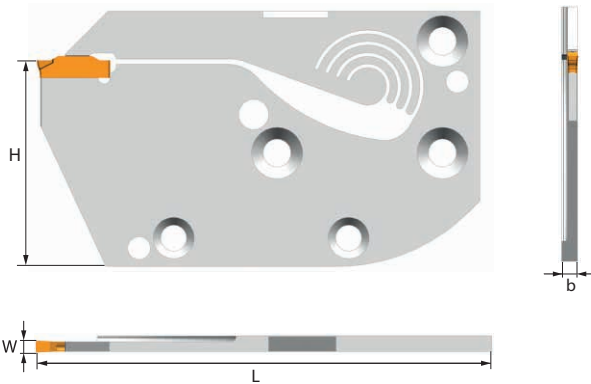

Article	*	Stock		Dimensions [mm]					Insert
		R	L	W	H	a _r max.	L	b	
ZF.2.2.B.R/L80.EC	ext.	●	●	2,0	37,4	80	118,5	4,0	Z*BS02002
ZF.2.2.E.R/L80.EC	ext.	●	●	2,5	37,4	80	118,5	4,0	Z*ES02502
ZF.2.2.F.R/L80.EC	ext.	●	●	3,0	37,4	80	118,5	4,0	Z*FS0303

● Ex stock ○ On demand

Spare parts

		Article	Stock
	Screw	ZF.2.M6x28	●
	Screw	ZF.2.M5x12	●
	Pin	ZF.2.D6x13	●
	Pin	ZF.2.D8x13	●
	Wrench	WH40L	●

Register on our website
and order online now.



www.zccct-europe.com

A

Turning

B

Milling

C



Drilling

D







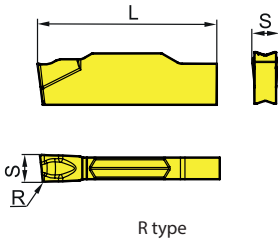

Technical Information

E

Index

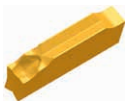
-  Ideal machining conditions
-  Normal machining conditions
-  Unfavourable machining conditions



Parting inserts











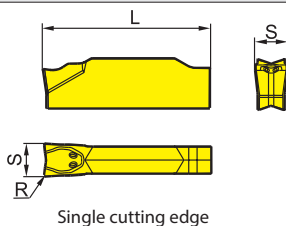

















Parting & grooving insert (single sided)							HC ¹ (CVD)	HC ¹ (PVD)	HW
 <p>R type</p>							P		
							M		
							K		
							N		
							S		
							H		
ISO	L ±0.1	R ±0.1	S ±0.1	θ	f		YB9320		
	ZPES02502-MG-6L NEW!	19,9	0,2	2,5	6°	0,03-0,08			
	ZPES02502-MG-6R NEW!	19,9	0,2	2,5	6°	0,03-0,08			
	ZPFS0302-MG-6L NEW!	19,9	0,2	3	6°	0,04-0,1			
	ZPFS0302-MG-6R NEW!	19,9	0,2	3	6°	0,04-0,1			

● Ex stock ○ On demand

HC¹ Coated carbide
HW Uncoated carbide

Parting inserts

-  Ideal machining conditions
-  Normal machining conditions
-  Unfavourable machining conditions

Parting & grooving insert (single sided)							HC ¹ (CVD)	HC ¹ (PVD)	HW	
 <p>Single cutting edge</p>							P		  	
							M		  	
							K			
							N			
							S		 	
							H			
ISO	L ±0.1	R ±0.1	S ±0.10	f		YBC251	YB9320 YBG202 YBG302	YD201		
	ZPES02502-MG	19,9	0,2	2,5	0,03-0,1		 			
	ZPFS0302-MG	19,9	0,2	3	0,04-0,13		 			
	ZPGS0402-MG	19,9	0,2	4	0,07-0,18		 			
	ZPGS0402-MG-25 NEW!	24,6	0,2	4	0,07-0,18					
	ZPHS0503-MG	19,9	0,3	5	0,1-0,24		 			
	ZPHS0503-MG-25 NEW!	24,6	0,3	5	0,1-0,24					
	ZPKS0604-MG	19,9	0,4	6	0,12-0,29		 			
ZPKS0604-MG-25 NEW!	24,6	0,4	6	0,12-0,29						

● Ex stock ○ On demand

HC¹ Coated carbide
HW Uncoated carbide

A

Turning

B

Milling

C

Drilling

D



Technical Information

E





Index

A

Turning

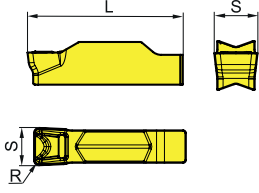
-  Ideal machining conditions
-  Normal machining conditions
-  Unfavourable machining conditions

Parting inserts

Parting & grooving insert (single sided)						HC ¹ (CVD)	HC ¹ (PVD)	HW				
						P						
						M						
						K						
						N						
						S						
						H						
ISO						L±0.1	R±0.1	S±0.10	f		YB9320	
	ZTES02503-MM NEW!					19,9	0,3	2,5	0,03-0,1		●	
	ZTFS0303-MM NEW!					19,9	0,3	3	0,04-0,13		●	
	ZTGS0404-MM-25 NEW!					24,6	0,4	4	0,06-0,18		●	
	ZTHS0504-MM-25 NEW!					24,6	0,4	5	0,08-0,23		●	
	ZTKS0608-MM-25 NEW!					24,6	0,8	6	0,12-0,27		●	

● Ex stock ○ On demand

HC¹ Coated carbide
HW Uncoated carbide

B

Milling

C

Drilling

D

Technical Information

E

Index

Register on our website and order online now.



www.zcct-europe.com

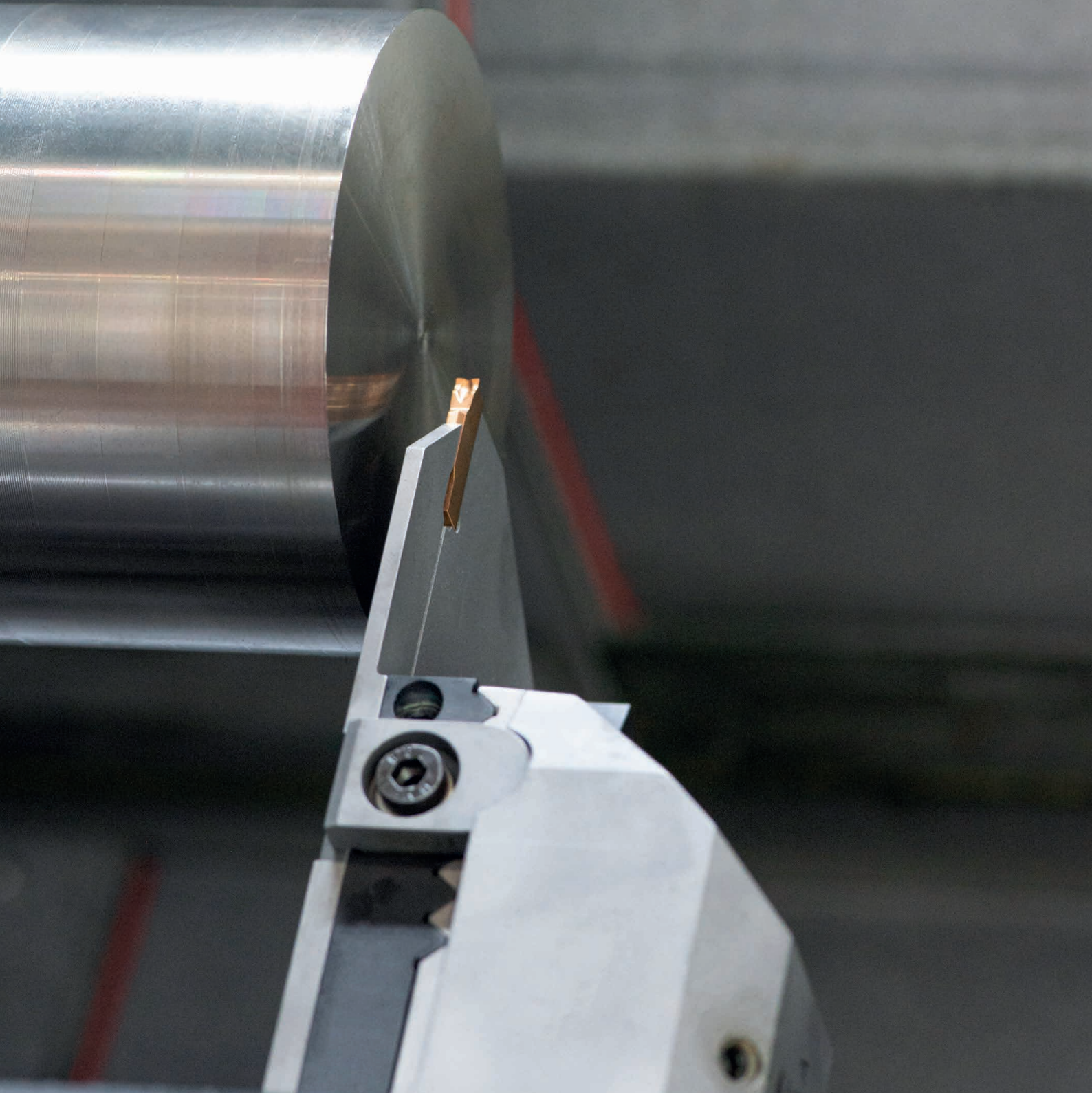

zFlex – Modular grooving system

Maintain flexibility in your production operations!

Notes

A

Turning

B

Milling

C

Drilling

D

Technical
Information

E

Index

Notes section with horizontal dotted lines for writing.

Solid carbide milling

System code – JIS series

A50

UM series

A51–A52

UMC series

A53–A55

Recommended cutting data

A56–A59

B

A

Turning

B

Milling

C

Drilling

D

Technical
Information

E

Index

GM – 2 E L P – D12 R0.5 – M08

1

2

3

4

5

6

7

8

A

Turning

B

Milling

C

Drilling

D

Technical Information

E

Index

Application	
Code	Description
GR	General roughing
GM	Semi-finishing
GF	Finishing
PM	High-performance machining
EPM	«Ecoline» – High-performance machining
VPM	Full-slot applications
HM	Hard machining
NM	General machining of non-ferrous metals
AL	General machining of Al and Al alloys
ALP	High-performance machining of Al and Al alloys
ALG	General machining of Al and Al alloys
UM	HSC/HPC machining
UMC	HSC machining with chip splitter geometry
VSM	General machining of heat-resistant alloys
TM	General machining of heat-resistant alloys

Number of teeth

1

2

Cutting edge type	
Code	Description
E	Square shoulder mill with protective chamfer
F	Square shoulder mill with sharp cutting edges
B	Ball nose cutter
R	Torus mill
W	Ripper
H	High-feed mill

Cutting edge length	
Code	Description
L	Long
X	Extra long
F	Short

Type	
Code	Description
S	Mini diameter
P	Ground neck
C	Conical neck

3

4

5

Diameter [mm]	
Code	Description
D3.0	3,0
D20.0	20,0
...	

Radius [mm]	
Code	Description
R0.5	0,5
R3.0	3,0
...	

Features	
Code	Description
G	Spiral angle 30°
M	Neck length [mm]
S	Thin shank
AIR	For aerospace industry

6

7

8

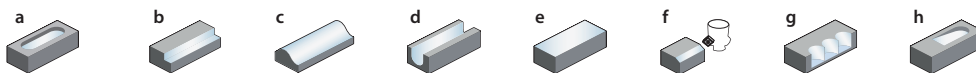

a Groove milling b Square shoulder milling c Profile milling d Slot milling e Face milling f Chamfer milling g Plunge milling
h Circular milling/Ramping

UM series

High Speed Cutter (HSC)



UM-5EP

End mills with five cutting edges and neck for increased productivity and versatility

- For roughing and finishing of steel up to 55 HRC, stainless steel and cast iron with high metal removal rate
- Optimised geometry with unequal helix angle (38°/41°) and unequal pitch
- End mills and torus mills
- Diameter range 4.0–25.0 mm



A

End mill

HSC/HPC machining

Turning

UM-5EP-W

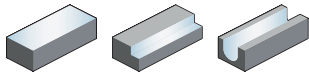

- Factory standard
- Non-centre cutting
- Helix angle 38°/39°/40°

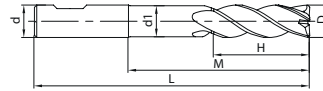

B

Milling

Article	*	Dimensions [mm]						Teeth	Grade
		D	d (h6)	d ₁	H	M	L		KMG405
UM-5EP-D6.0-W		6	6	5,7	16	22	58	5	●
UM-5EP-D8.0-W		8	8	7,7	21	27	63	5	●
UM-5EP-D10.0-W		10	10	9,5	24	35	75	5	●
UM-5EP-D12.0-W		12	12	11,5	31	43	88	5	●
UM-5EP-D16.0-W		16	16	15,5	36	52	100	5	●
UM-5EP-D20.0-W		20	20	19,5	41	72	126	5	●
UM-5EP-D25.0-W		25	25	24	51	102	160	5	○

● Ex stock ○ On demand

* With internal cooling

C

Drilling

Application field

P	M	K	N	S	H
✓	✓	✓			✓

✓ Very suitable

✓ Suitable

D

Technical Information

E

Index

Register on our website and order online now.



www.zcct-europe.com

UMC series

Short chips even with long cutting edges

YOUR BENEFITS

- Increased productivity in trochoidal and HSC machining operations
- Uninterrupted cutting actions for lower cutting forces
- Enhanced chip evacuation especially during pocket machining operations
- Optimally prepared cutting edges for smoother operation and a longer tool life

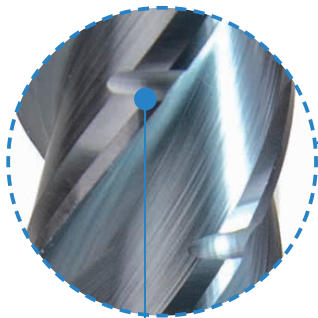

Chip breaker reduces cutting forces to a minimum and facilitate chip removal all while maintaining a consistent surface quality



Two-tier core design for optimum tool stability

Reduced neck for maximum usable depths

Fig.: UMC-4E-D12.0 KMG405

A

End mill HSC/HPC machining

UMC-4E

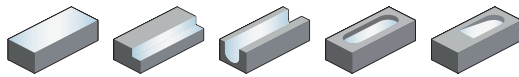

- Factory standard
- Centre cutting
- Helix angle 38°/40°

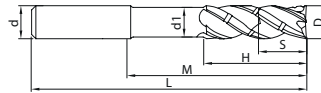

Turning

B

Article	*	Dimensions [mm]							Teeth	Grade
		D	d (h6)	d ₁	H	M	L	S		KMG405
UMC-4E-D6.0		6	6	5.8	18	24	60	9	4	○
UMC-4E-D8.0		8	8	7.8	24	34	70	12	4	○
UMC-4E-D10.0		10	10	9.6	30	40	80	15	4	○
UMC-4E-D12.0		12	12	11.5	36	45	90	18	4	○
UMC-4E-D16.0		16	16	15.5	48	62	110	24	4	○
UMC-4E-D20.0		20	20	19.5	60	80	130	30	4	○

- Ex stock ○ On demand
- * With internal cooling

Milling

C

Application field						
P	M	K	N	S	H	
✓	✓	✓			✓	✓ Very suitable
						✓ Suitable

Drilling

D

Technical Information

E

Index

Register on our website and order online now.



www.zcct-europe.com

End mill **HSC/HPC machining**

UMC-4E-W

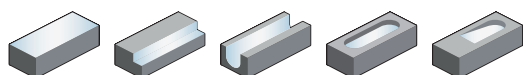

- Factory standard
- Centre cutting
- Helix angle 38°/40°

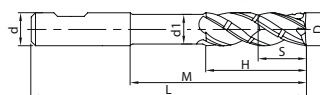

Article	*	Dimensions [mm]							Teeth	Grade
		D	d (h6)	d ₁	H	M	L	S		KMG405
UMC-4E-D6.0-W		6	6	5.8	18	24	60	9	4	○
UMC-4E-D8.0-W		8	8	7.8	24	34	70	12	4	○
UMC-4E-D10.0-W		10	10	9.6	30	40	80	15	4	○
UMC-4E-D12.0-W		12	12	11.5	36	45	90	18	4	○
UMC-4E-D16.0-W		16	16	15.5	48	62	110	24	4	○
UMC-4E-D20.0-W		20	20	19.5	60	80	130	30	4	○

● Ex stock ○ On demand

* With internal cooling

Application field					
P	M	K	N	S	H
✓	✓	✓			✓

✓ Very suitable

✓ Suitable

A

Turning

B

Milling

C

Drilling

D

Technical Information

E

Index

End mill – HPC/UM/UMC/VSM series

	Material group	Composition / structure / heat treatment	Brinell hardness HB	Machining group	Starting values for cutting speed v_c [m/min]								
					5501R38414GM (-R) 5502R38414GM (-R) 5602R38414GM (-R)				5501R38414GM 5502R38414GM 5602R38414GM				
					Slot milling		Shoulder milling		Slot milling		Shoulder milling		
					\varnothing [mm]	$a_{p,max}$	\varnothing [mm]	$a_{e,max}$	\varnothing [mm]	$a_{p,max}$	\varnothing [mm]	$a_{e,max}$	
					$0 < x < 3$	$0,3 \times D$	$0 < x < 3$	$0,15 \times D$	$0 < x < 3$	$0,3 \times D$	$0 < x < 3$	$0,15 \times D$	
					$3 \leq x < 12$	$0,7 \times D$	$3 \leq x < 20$	$0,3 \times D$	$3 \leq x < 12$	$0,7 \times D$	$3 \leq x < 20$	$0,3 \times D$	
					$12 \leq x \leq 20$	$1,5 \times D$			$12 \leq x \leq 20$	$1,5 \times D$			
					KMG405				KMG406				
					a_e / D				a_e / D				
					1/1	1/2	1/10	f-group	1/1	1/2	1/10	f-group	
A Turning	P Unalloyed steel	approx. 0,15 % C	annealed	125	1	250	300	380	9	230	280	350	9
		approx. 0,45 % C	annealed	190	2	240	285	365	9	220	270	340	9
		approx. 0,45 % C	tempered	250	3	175	210	270	9	160	190	250	9
		approx. 0,75 % C	annealed	270	4	150	180	230	9	140	160	210	9
		approx. 0,75 % C	tempered	300	5	140	165	210	9	130	150	200	9
B Milling	P Low-alloyed steel		annealed	180	6	190	225	285	9	180	215	270	9
			tempered	275	7	150	180	230	9	130	170	220	9
			tempered	300	8	140	165	210	9	125	150	190	9
			tempered	350	9	130	160	200	9	120	150	190	9
C Drilling	P High-alloyed steel and high-alloyed tool steel		annealed	200	10	175	210	270	9	160	190	250	9
			hardened and tempered	325	11	135	160	205	9	115	140	190	9
D Technical Information	M Stainless steel	ferritic/martensitic	annealed	200	12	80	100	125	9	70	90	110	9
		martensitic	tempered	240	13	70	85	110	9	60	80	100	9
		austenitic	quench hardened	180	14	85	105	130	9	75	90	120	9
		austenitic-ferritic		230	15	70	85	110	9	65	80	100	9
E Index	K Grey cast iron	perlitic/ferritic		180	16	185	220	280	9	160	200	260	9
		perlitic (martensitic)		260	17	150	180	230	9	140	170	220	9
	K Cast iron with spheroidal graphite	ferritic		160	18	225	270	345	9	215	250	330	9
		perlitic		250	19	175	210	270	9	160	200	250	9
	K Malleable cast iron	ferritic		130	20	250	300	380	9	230	280	360	9
perlitic			230	21	200	240	305	9	180	230	290	9	
F Index	N Aluminium wrought alloys	cannot be hardened		60	22								
		hardenable	hardened	100	23								
	N Cast aluminium alloys	$\leq 12\% \text{ Si}$, cannot be hardened		75	24								
		$\leq 12\% \text{ Si}$, hardenable	hardened	90	25								
		$> 12\% \text{ Si}$, cannot be hardened		130	26								
N Copper and copper alloys (bronze/brass)	machining steel, PB> 1%			110	27								
	CuZn, CuSnZn			90	28								
	CuSn, Pb-free copper, electrolytic copper			100	29								
S Heat-resistant alloys	S Fe-based alloys	annealed		200	30								
		hardened		280	31								
	S Ni or Co bass	annealed		250	32								
		hardened		350	33								
		cast		320	34								
S Titanium alloys	pure titanium		R_m 400	35									
	α and β alloys	hardened	R_m 1050	36									
H Hardened steel	H Hardened steel	hardened and tempered		55 HRC	37	115	140	175	9	100	120	150	9
		hardened and tempered		60 HRC	38								
	H Hard cast iron	cast		400	39	135	165	205	9	110	150	180	9
X Non-metallic materials	X Non-metallic materials	hardened and tempered		55 HRC	40								
		Thermoplasts			41								
		Thermosetting plastics			42								
		Plastic, glass-fibre reinforced GFRP			43								
		Plastic, carbon fibre reinforced CFRP			44								
		Graphite			45								
Wood			46										

Note: The given cutting values are guide values, which were determined under ideal conditions.
The values have to be adapted in individual cases.
Feed rate recommendations on page B460.
For examples of material for cutting tool groups view page D22.

Recommended feed rate

Solid carbide milling group 9 – Square shoulder mills UM/UMC series HSC/HPC

	a_e / D	Feed rate per cutting edge (f_z) [mm]																	
		Ø 4	Ø 5	Ø 6	Ø 8	Ø 10	Ø 12	Ø 14	Ø 16	Ø 18	Ø 20								
P	1/1	0,06	0,06	0,06	0,07	0,07	0,07	0,07	0,08	0,08	0,08								
	1/2	0,08	0,08	0,08	0,09	0,09	0,09	0,09	0,10	0,10	0,10								
	1/10	0,14	0,14	0,16	0,18	0,22	0,25	0,27	0,3	0,32	0,36								
M	1/1	0,05	0,05	0,05	0,05	0,05	0,05	0,05	0,06	0,06	0,06								
	1/2	0,06	0,06	0,06	0,07	0,07	0,07	0,07	0,08	0,08	0,08								
	1/10	0,10	0,10	0,10	0,12	0,12	0,14	0,16	0,16	0,18	0,18								
K	1/1	0,06	0,06	0,06	0,07	0,07	0,07	0,07	0,08	0,08	0,08								
	1/2	0,08	0,08	0,08	0,09	0,09	0,09	0,09	0,10	0,10	0,10								
	1/10	0,14	0,14	0,16	0,18	0,22	0,25	0,27	0,3	0,32	0,36								
H	1/1	0,045	0,045	0,045	0,053	0,053	0,053	0,053	0,06	0,06	0,06								
	1/2	0,06	0,06	0,06	0,07	0,07	0,07	0,07	0,08	0,08	0,08								
	1/10	0,10	0,10	0,10	0,12	0,12	0,14	0,16	0,16	0,18	0,18								

Note: The given cutting values are guide values, which were determined under ideal conditions.
The values have to be adapted in individual cases.

A

Turning

B

Milling

C

Drilling

D

Technical Information

E

Index



Scan for PDF



Europe head office

ZCC Cutting Tools Europe GmbH

www.zccct-europe.com

Wanheimer Str. 57, 40472 Düsseldorf, Germany

Tel.: +49 (0) 211-989240-0

Fax: +49 (0) 211-989240-111

E-Mail: info@zccct-europe.com

France branch office

ZCC Cutting Tools Europe GmbH Succursale Française

www.zccct-europe.com

14, Allée Charles Pathé, 18000 Bourges, France

Tel.: +33 (0) 2 45 41 01 40

Fax: +33 (0) 800 74 27 27

E-Mail: ventes@zccct-europe.com

UK branch office

ZCC Cutting Tools Europe GmbH UK Division

www.zccct-europe.com

4200 Waterside Centre, Solihull Parkway

Birmingham Business Park

Birmingham, West Midlands, B37 7YN, UK

Tel.: +44 (0) 121 8095469

Fax: +49 (0) 211-989240-111

E-Mail: infouk@zccct-europe.com

© Copyright by ZCC Cutting Tools Europe GmbH
All rights reserved.

All rights reserved. All descriptions and pictures are protected by copyright. Usage, modification and reproduction, completely or partially, without written permission are prohibited. Subject to technical changes and changes of the delivery program. Mistakes and printing errors are reserved.